

REF:

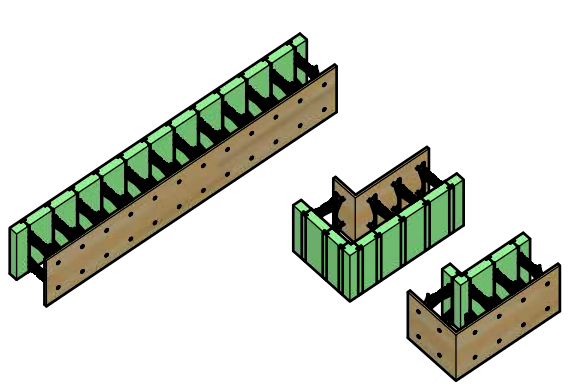

one
series

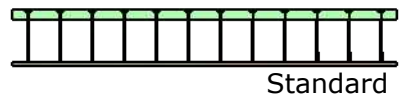

Standard

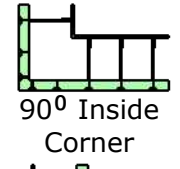

90° Inside Corner

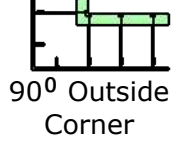

90° Outside Corner

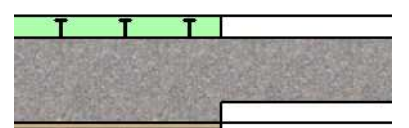

Finished face of cast concrete lines through with exterior of ICF block

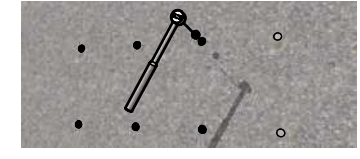

Web connectors can be removed after the ply forms have been taken down. Simply use a 3/8" square ratchet & finish as required

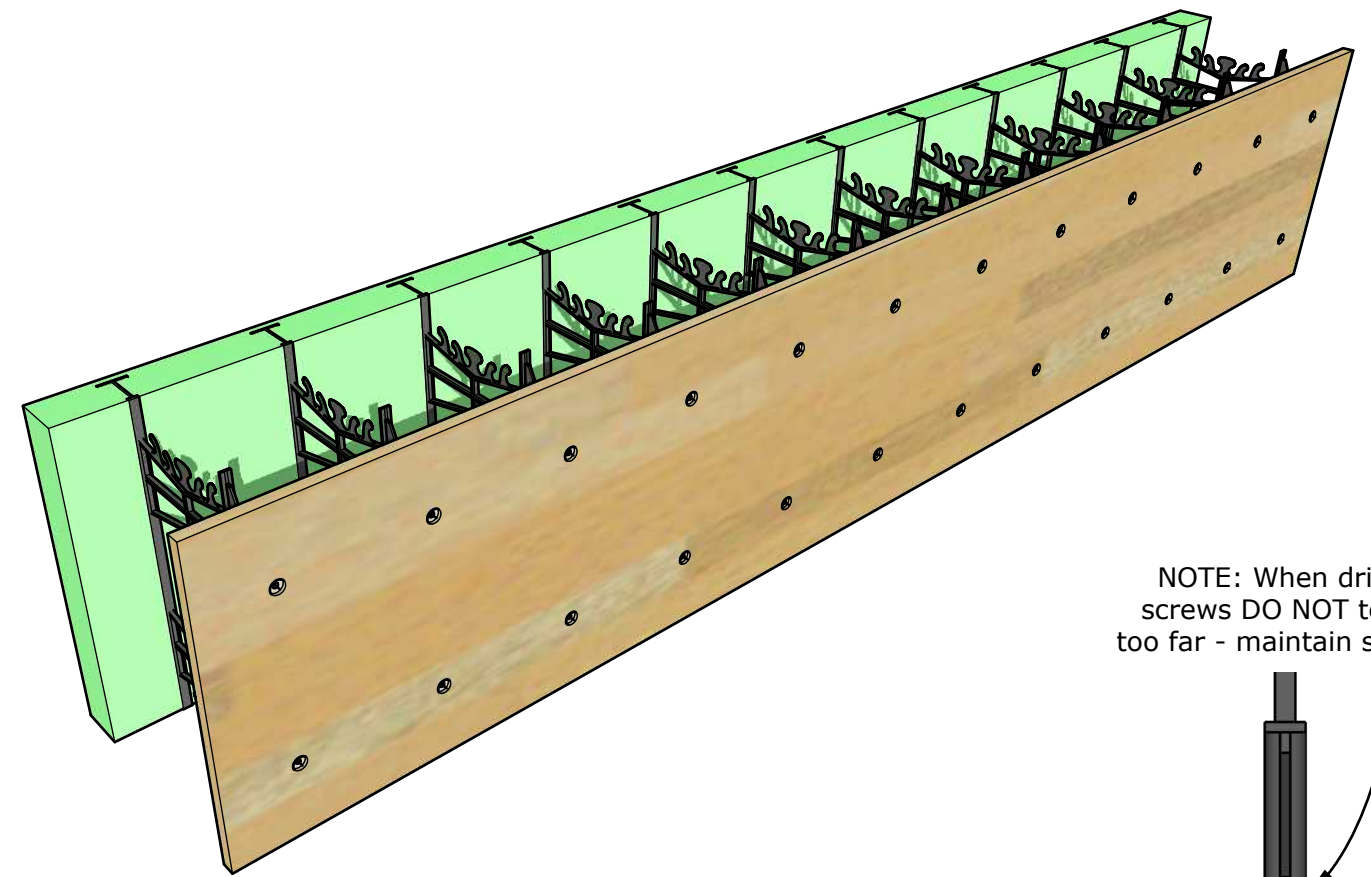

NOTE: When driving screws DO NOT torque too far - maintain standoff

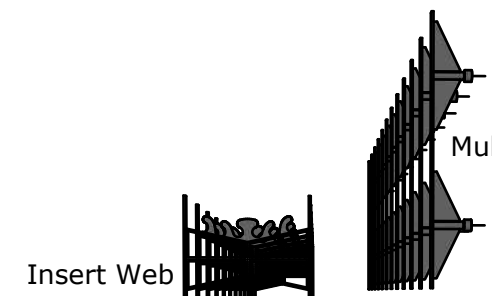
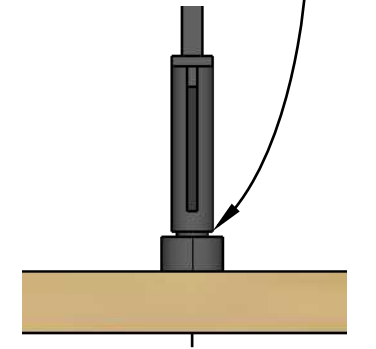

Insert Web

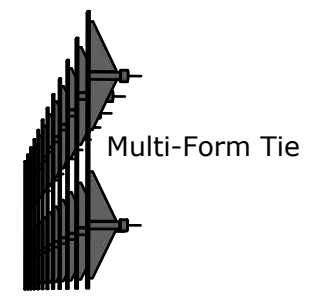

Multi-Form Tie

EPS Panel

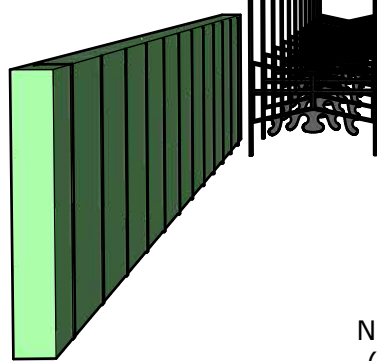

Nudura Plywood Panel (pre-cut, pre-drilled)

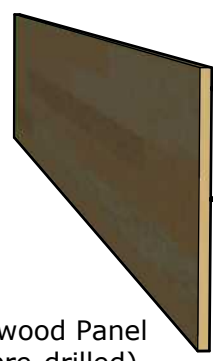

#10-2" Hex Hd Screw w/ washer

Nudura Jig

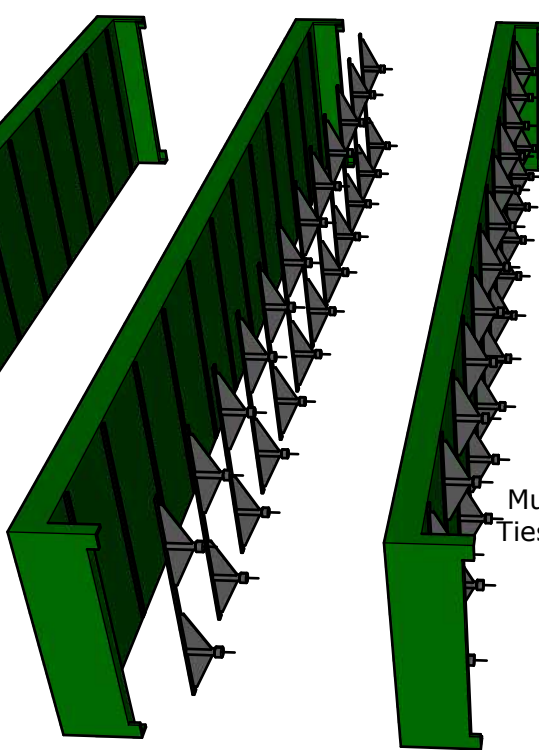
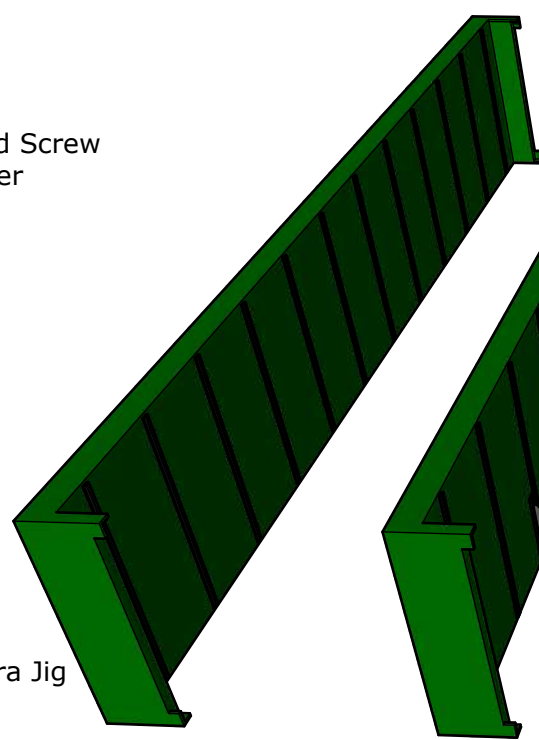

Multi-Form Ties in place

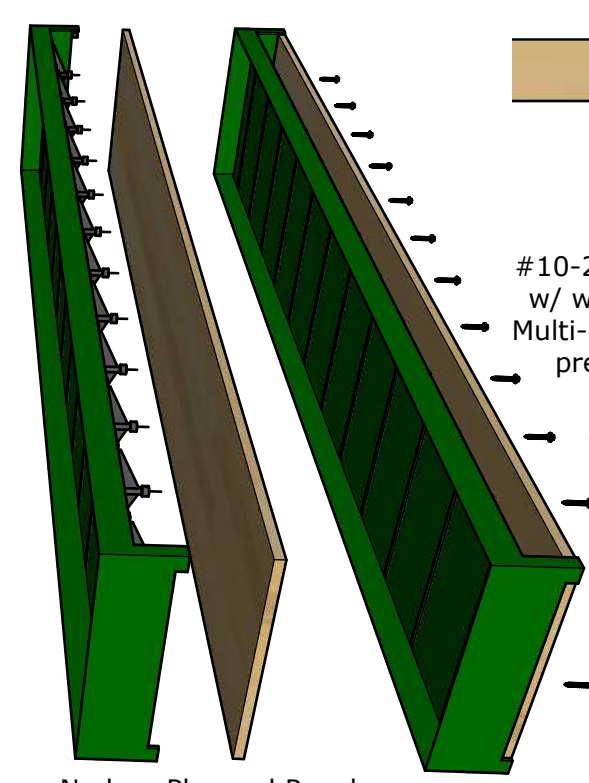

Nudura Plywood Panel positioned by jig (recessed holes facing up)

#10-2" Hex Hd Screws w/ washer secured to Multi-Form Ties through pre-drilled holes



PROPRIETARY AND CONFIDENTIAL
THE INFORMATION CONTAINED IN THIS DRAWING IS THE SOLE PROPERTY OF FAB-FORM INDUSTRIES LTD. ANY REPRODUCTION IN PART OR AS A WHOLE WITHOUT THE WRITTEN PERMISSION OF FAB-FORM INDUSTRIES IS PROHIBITED

VANCOUVER ICF

www.vancouvericf.com (604)229-9829

DRAWN:
DO NOT SCALE DRAWING

CHECKED:
WEIGHT:

APPROVED:
DATE:

TITLE:
Nudura One Series

DRG NO:
Standard

REV: